

COMS

COMS with SECON, Installation Quick Guide for 2-float probes

Edition: 2021-09
Version: 2
Art. No. 350316



© Copyright:

Reproduction and translation are permitted only with the written consent of the FAFNIR GmbH. The FAFNIR GmbH reserves the right to make product alterations without prior notice.

Table of contents

1	Installation of the VISY-Stick Oil Separator and VISY-Sludge	1
2	Basic settings in VISY-Setup	3
3	Configuration.....	4
3.1	Network connection between SECON client and laptop	4
3.2	Configuration of the SECON client with the laptop	6

1 Installation of VISY-Stick Oil Separator and VISY-Sludge



The oil separator is Ex zone. Observe safety regulations!



During the six-monthly inspection of the oil separator, the VISY-Stick Oil probes with two floats and the VISY-Sludge must be cleaned of dirt and adhesions with a damp cloth.



The COMS system fulfils the functions of an automatic warning system for separators of light liquids. The alarms can be forwarded on request with potential-free change-over contacts.

- a) To connect the sensors, a 4-core cable from the oil separator to the petrol station building must be available.
- b) Clean the oil separator (light liquid separator and sludge trap) and fill it to overflowing with water.
- c) Install VISY-Command Web or alternatively VISY-Command with a SECON client.
- d) Install VISY-Stick Oil Separator (mechanically).
For installation of the measuring sensor, the oil reservoir of the oil separator must be within the measuring range of the VISY-Stick Oil Separator.
Note: The dimensions $a_3 = 240$ mm and $a_4 = 100$ mm must not be undercut!

See also



User guide for determining the length and positioning of the probes for an oil separator. (See next figure)

- e) Install VISY-Sludge (mechanically).
The measuring sensor must be installed that it
 - is positioned below the maximum oil layer thickness and
 - at least 200 mm above the maximum sludge thickness, and
 - has a maximum distance of 1400 mm to the bottom of the sludge trap.
- f) Electrically connect VISY-Stick Oil separator and VISY-Sludge with the FAFNIR connection cable and, if necessary, an extension to VISY-Command (Web).

 The oil separator is Ex zone. Observe safety regulations!

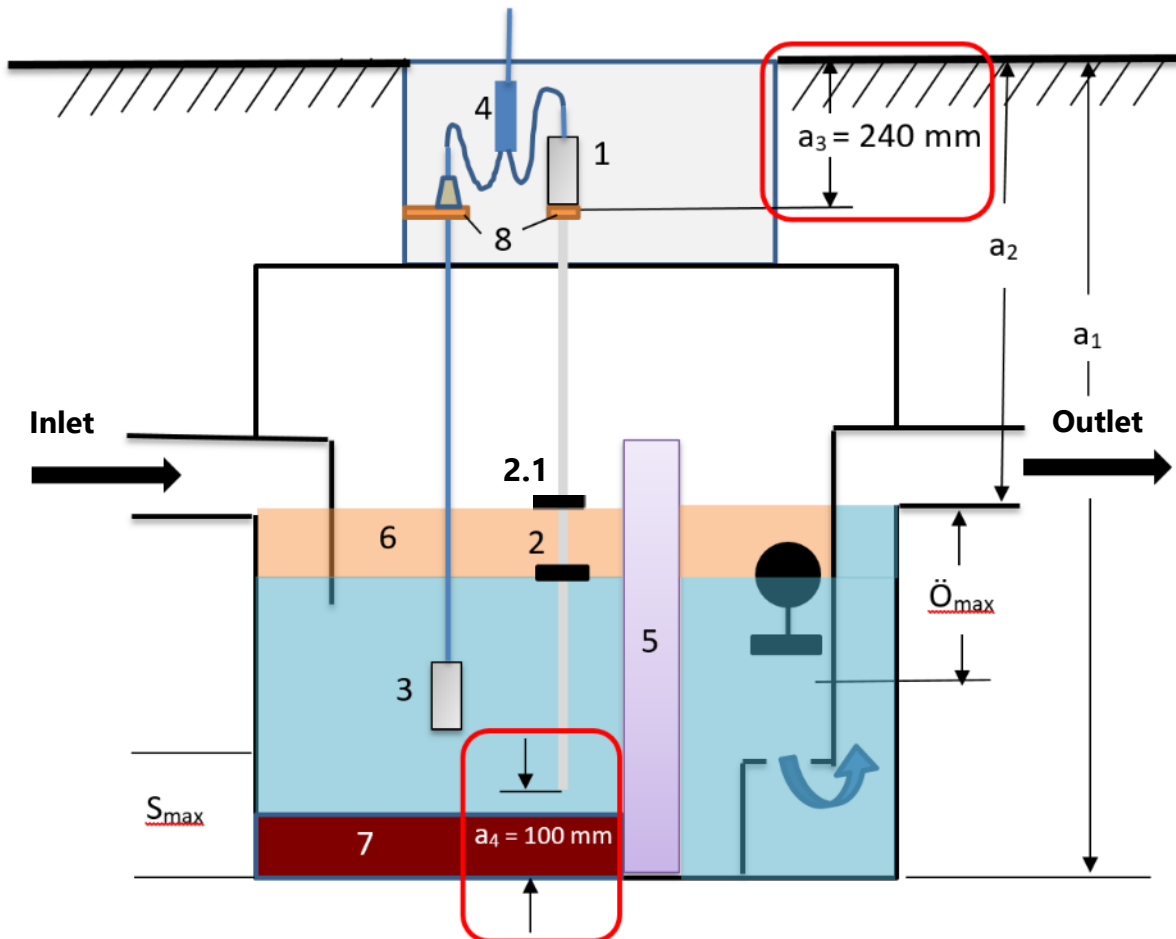

O_{max} = maximum oil layer thickness

a_1 = separator depth

a_3 = safety distance = 240 mm

1 = VISY-Stick Oil Separator

3 = VISY-Sludge

5 = coalescence filter

7 = mud layer

S_{max} = maximum sludge layer thickness

a_2 = distance (road - overflow)

a_4 = safety distance to the ground = 100 mm

2 = interface float

2.1 = product float

4 = cable connector (2-1)

6 = oil layer

8 = mounting bracket

2 Basic settings in VISY-Setup

To configure the VI-4 board in VISY-Command (Web), you must use **VISY-Setup** software **version 4.7.1.255** or higher.

The **VI-4 board** must be equipped with firmware **version 4.2.3.255** or higher.

- a) Adjust the "**Data protocol** for communication with VISY-Stick" to "Multi Probe 4800 bps":
Menu:
Central unit [F2] → Advanced settings → Data Protocol for VISY-Stick communication → Select and accept "Multi Probe 4800 bps"

- b) Enter the **device numbers** of VISY-Stick Oil separator / VISY-Sludge:
Menu:
Select Probes [F4] → select the "Probe Terminal No." of the sensor → select the measuring sensor (VISY-Stick or VISY-Sludge) → enter the "**Serial number of the probe**".

- c) Select **Type of product** for the oil separator:
Menu:
Probes [F4] → Type of Product:
- Select "**light fluid**"

- d) Enter the **Product Name**:
Menu:
Probes [F4] → Product name: Enter **Oil separator #**
(# = **number of the oil separator**)

- f) Read and note the **Product Level** (float position) of VISY-Stick Oil Separator and the **Distance** of the VISY-Sludge probe to the bottom:
Menu:
Select Current Values [F1] → Select Probe Terminal No." → Select the measuring sensor (VISY-Stick / VISY-Sludge)
- **Product Level (for VISY-Stick) and**
- **Distance (for VISY-Sludge)**
are to be noted down

3 Configuration



For configuration the internet browser "Mozilla Firefox" is required.



The router must be set to Dynamic Host Configuration Protocol (DHCP)!



The SECON software version 2.3.19.05 or higher must be installed

3.1 Network connection between SECON client and laptop

a) Connect your notebook via network cable to the router to which the SECON Client/ VISY-Command Web is connected.

b) To access the configuration menu of the SECON client, enter:

User: admin

Password: vap22765

c) Change **language** to xxx:

Configuration - Settings - Language → Select language (English)



- d) Determine the IP address of the laptop
- In the Run dialog box (Windows key + R), type **"cmd"** and press ENTER
 - In the command line window that opens, enter the command **"ipconfig"** and press ENTER -> the IP address of the laptop is displayed:

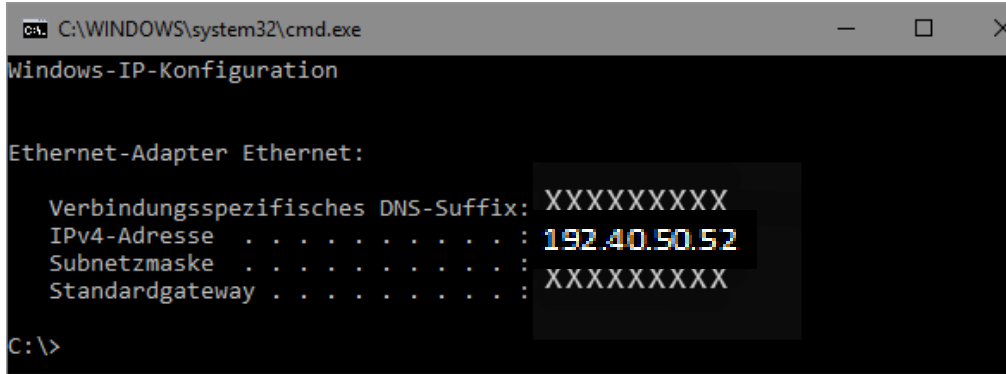

- e) Enter the IP address of the laptop in SECON client:
 Menu: Configuration – Settings – Via browser
 Enter the last digits after the point of the Laptop **IPv4 address** in the field "Laptops / PCs IP address" of the SECON client (*in this example 52, see picture above*):

Konfiguration » Einstellungen » per Browser	
SECONs IP Adresse:	192.40.50.146
Laptops / PCs IP Adresse:	192.40.50. <input type="text"/>
<input type="button" value="Löschen"/> <input type="button" value="Starten"/>	

- f) Press the "Start" button
- g) Following is a confirmation with the IP addresses that an https connection to the laptop has been established (see the following figure).

Konfiguration » Einstellungen » per Browser	
Info: Die Konfiguration wurde erfolgreich gespeichert.	
Info: Jetzt können Sie diesen SECON per Browser konfigurieren. Der SECON ist unter folgender Adresse zu erreichen: https://192.40.50.146	
SECONs IP Adresse:	192.40.50.146
Laptops / PCs IP Adresse:	<input style="border: 2px solid red;" type="text" value="192.40.50.52"/>
<input type="button" value="Löschen"/> <input type="button" value="Stoppen"/>	

3.2 Configuration of the SECON client with the laptop

- a) Start the internet browser "**Mozilla Firefox**" on your laptop.
- b) In the address bar of the browser, enter the IP address of SECON client.
(in this example it is the address https://192.40.50.146).

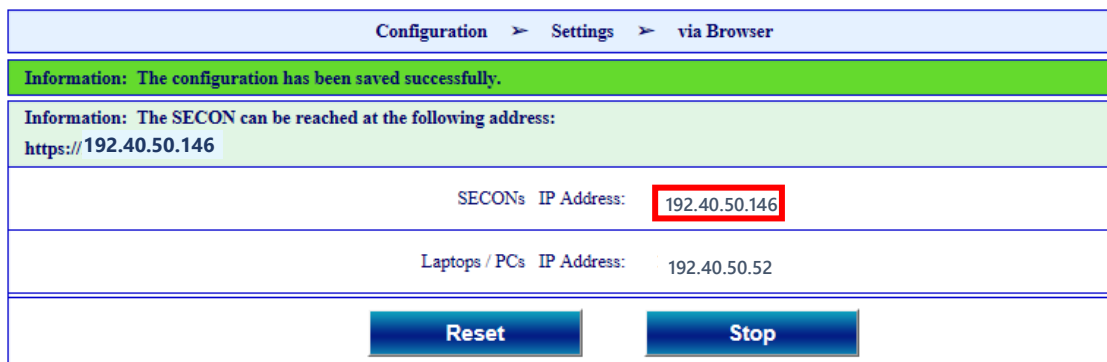

- c) In the browser the following window opens.
Enter your user name and password:
User name: admin
Password: Fafnir22765Altona
and confirm with OK

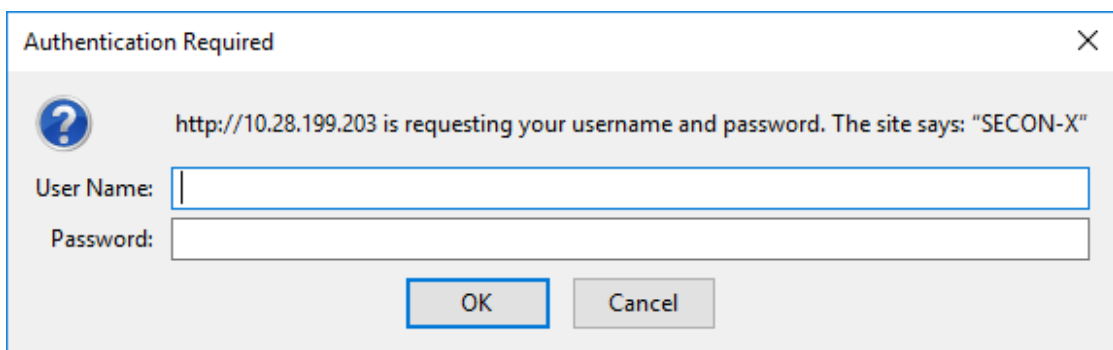

- d) The configuration wizard starts. Press the "Next" button

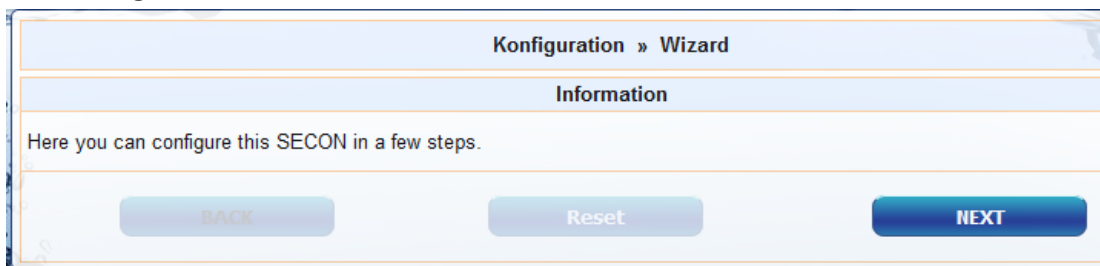

- e) Select options "**Station data**" and "**Oil Separator**"

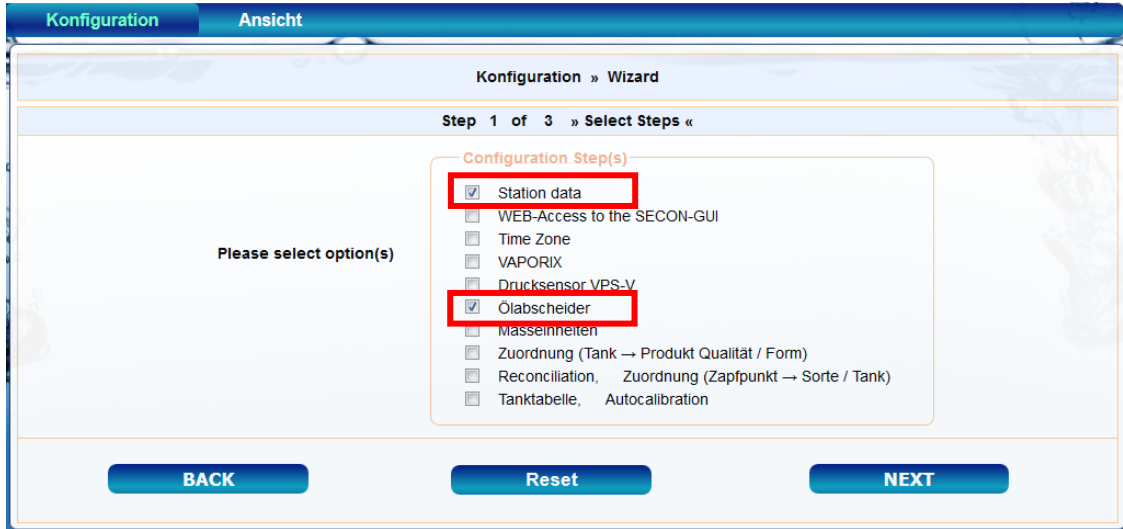

Press the "NEXT" button

- f) Enter the station data:

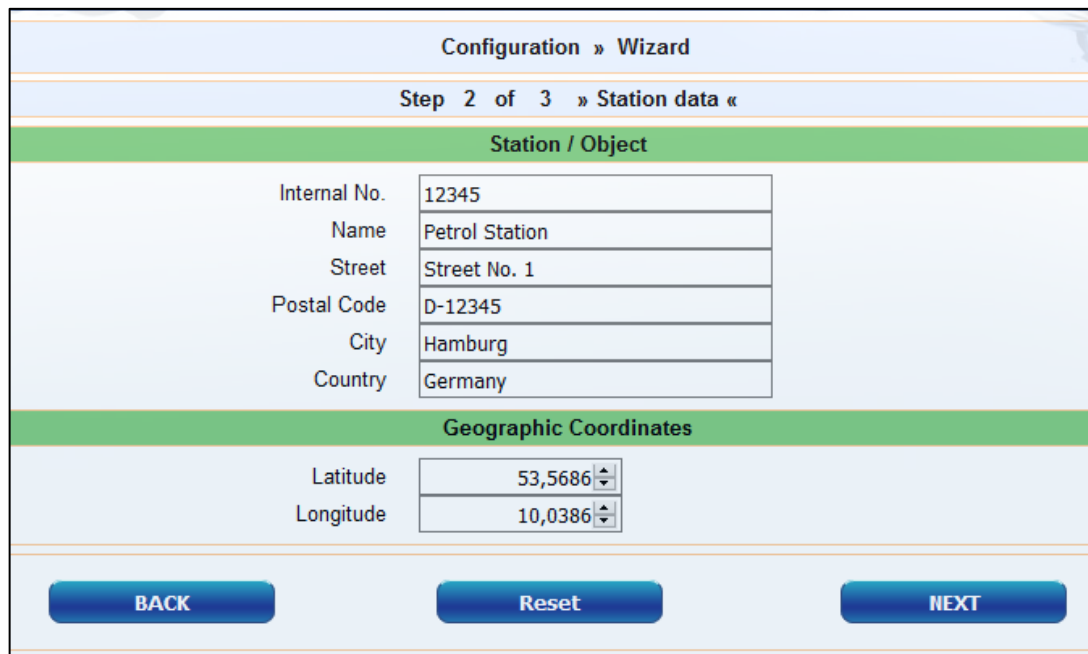

- g) Determination of geographic coordinates (latitude and longitude, optional):

1. Open the internet browser
2. Start Google Maps
3. Right click on the location of the station with the mouse
4. In the opened context menu select "What is here?"
5. The coordinates are displayed (latitude / longitude)
6. Enter the geographical coordinates in the according fields
7. Press the "NEXT" button

h) Configuration of the oil separators and the evaluation

The following window is divided into three sections:

1. INFORMATION: Detected probes (sludge probe / tank probe)
2. Common settings for all oil separators
3. Settings for individual oil separators

1. INFORMATION: Detected probes

The measured values of the [Sludge Probe »VISY-Sludge«](#) and the [Tank Probe »VISY-Stick«](#) are displayed here.

Step 3 of 3 » Ölabscheider «

INFORMATION: Detektierte Sonden [2019-05-20 13:33:15]

Schlammsonde » VISY-Sludge «			Tanksonde » VISY-Stick «		
Sonde Nr.	Messwerte	Lev.[mm]	Produkt-Name / Sonde Nr.	Messwerte	Lev.[mm]
			Produkt	Water	
6		900.0	Öl	1996.2	1966.0

2. Common settings for all oil separators

"[Logging](#)" area:

The settings in this area should remain unchanged.

The checkbox "Activation" is already activated by default.

"[Options](#)" area:

- [Time-out maintenance after](#): 8 hours (recommendation)
- [Day of monthly inspection](#): 0 (recommendation)
- [Alarm repeat »Light fluid too long constant« after](#): 1 or 2 day (s) (recommendation)

Gemeinsame Einstellungen für alle Ölabscheider

Logging	Optionen
Aktivierung <input checked="" type="checkbox"/>	Autom. Beenden der Wartung nach <input type="text" value="8"/> Std.
Intervall <input type="text" value="1"/> Std.	Tag der monatlichen Sichtprüfung <input type="text" value="0"/>
Start Zeit <input type="text" value="00:00"/>	Alarmwiederholung »Leichtflüss. zu lange konstant« nach <input type="text" value="2"/> Tag(e)

3. Settings for individual oil separators

"Oil separator" area:

- **Number**: freely selectable; e.g. **1** for the first oil separator ...
- **Name**: choose a significant name, e.g.: City (HH); Station Number: 54; Number of the oil separator: 12345678

The name would then be, for example: **HH-54-12345678**

Idx.	Settings for individual Oil Separators
	<div style="border: 1px solid #ccc; padding: 5px;"> <div style="display: flex; align-items: center; margin-bottom: 5px;"> ⚙️ Oil Separator </div> <div style="display: flex; justify-content: space-between;"> <div style="width: 45%;"> <p>Number <input style="width: 40px;" type="text" value="1"/></p> </div> <div style="width: 45%;"> <p>Identifier <input style="width: 100%;" type="text" value="HH-54-12345678"/></p> </div> </div> </div>

Section "Sludge probe »VISY-Sludge«":

- **Probe assigned to this oil separator**: Activate **the checkbox by a check mark**
- **Probe No.**: Probe terminal to which VISY-Sludge is connected.
- **Distance to oil separator bottom**: [See point 2f](#) [measured value VISY-Sludge]
- **Alarm threshold of the mud layer**: **50% of the maximum permitted mud layer**

⚙️
Sludge Probe » VISY-Sludge «

Assign probe to this Oil Sep.

Probe No.

Distance to Oil sep. bottom mm

Alarm threshold sludge layer mm

“Tank probe »VISY-Stick«” area:

- **Assign probe to this oil separator:** Activate **the checkbox by a check mark**
- **Probe No.:** Probe terminal to which VISY-Stick Oil Separator is connected.
- **Reference filling height:** Corresponds to the reference height: [See point 2f](#) [measured value VISY-Stick]
- **Max. light liquid volume:** enter here the maximum oil storage volume of the oil separator in **litres** - see also nameplate
- **Max. light liquid level:** enter here the maximum oil layer thickness that can be absorbed by the oil separator - see also nameplate
- **»Light liquid layer too thick« Alarm threshold:** Enter 80% of the maximum permitted oil layer thickness (see nameplate). It is necessary to check if the average volume can be taken up by the remaining 20%. Otherwise, the alarm threshold must be set to e.g 70%.

The average volume is calculated from the pump capacity of the dispenser with the highest flow rate per min. x 3.

Example 1: The highest pump capacity of the dispenser are 40 litres/minute => (40 L/min) x 3 min. = 120 litres

Example 2: The highest pump capacity of the dispenser are 80 litres/minute => (80 L/min) x 3 min. = 240 litres

- **»High level, retention« Alarm threshold:** enter here a value between **120** and **200** mm (measured from the reference height)

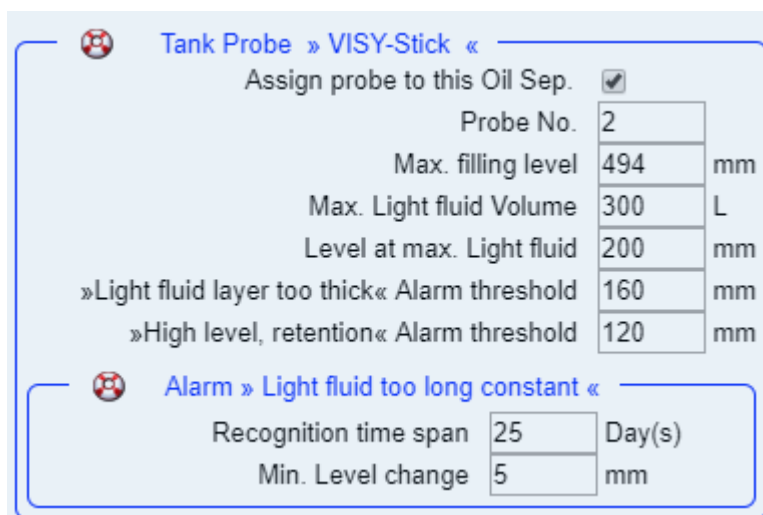

The screenshot shows a configuration window for the 'Tank Probe »VISY-Stick«'. It contains several settings:

- Assign probe to this Oil Sep.:**
- Probe No.:** 2
- Max. filling level:** 494 mm
- Max. Light fluid Volume:** 300 L
- Level at max. Light fluid:** 200 mm
- »Light fluid layer too thick« Alarm threshold:** 160 mm
- »High level, retention« Alarm threshold:** 120 mm

Below this, there is an 'Alarm » Light fluid too long constant «' section with the following settings:

- Recognition time span:** 25 Day(s)
- Min. Level change:** 5 mm

»Alarm »light liquid too long constant« area:

- Recognition time span: 25 days (recommendation)
- Minimum level change: 5 mm(recommendation)

If another oil separator is to be added, then press the "Add new Oil Separator" button:



If no further oil separator is to be added, then press the "NEXT" button:



Settings for individual Oil Separators	
1	Oil Separator Number <input type="text" value="1"/> Identifier <input type="text" value="HH-54-12345678"/>
	Sludge Probe » VISY-Sludge « Assign probe to this Oil Sep. <input checked="" type="checkbox"/> Probe No. <input type="text" value="2"/> Distance to Oil sep. bottom <input type="text" value="980"/> mm Alarm threshold sludge layer <input type="text" value="216"/> mm
	Tank Probe » VISY-Stick « Assign probe to this Oil Sep. <input checked="" type="checkbox"/> Probe No. <input type="text" value="2"/> Max. filling level <input type="text" value="494"/> mm Max. Light fluid Volume <input type="text" value="300"/> L Level at max. Light fluid <input type="text" value="200"/> mm »Light fluid layer too thick« Alarm threshold <input type="text" value="160"/> mm »High level, retention« Alarm threshold <input type="text" value="120"/> mm
	Alarm » Light fluid too long constant « Recognition time span <input type="text" value="25"/> Day(s) Min. Level change <input type="text" value="5"/> mm

END of configuration

Blank Page



FAFNIR GmbH
Schnackenburgallee 149 c
22525 Hamburg, Germany
T: +49 / 40 / 39 82 07-0
F: +49 / 40 / 390 63 39
E-mail: info@fafnir.com
Web: www.fafnir.com
