

COMS

COMS with SECON, Installation Quick Guide for 2-float probes

Edition: 2021-11
Version: 3
Art. No. 350316



© Copyright:

Reproduction and translation are permitted only with the written consent of the FAFNIR GmbH. The FAFNIR GmbH reserves the right to make product alterations without prior notice.

Table of contents

1	Installation of VISY-Stick Oil and VISY-Sludge	1
2	Basic settings in VISY-Setup	3
3	Configuration.....	4
3.1	Network connection between SECON-Client and notebook.....	4
3.2	Further configuration with the notebook.....	5

1 Installation of VISY-Stick Oil and VISY-Sludge



The oil separator is Ex zone. Observe safety regulations!



During the six-monthly inspection of the oil separator, the VISY-Stick Oil probes with two floats and the VISY-Sludge must be cleaned of dirt and adhesions with a damp cloth.



*The COMS system fulfils the functions of an automatic warning system for separators of light liquids. **Some** alarms can be forwarded on request with potential-free change-over contacts.*

- a) To connect the sensors, a 4-core cable from the oil separator to the petrol station building must be available.
- b) Clean the oil separator (light liquid separator and sludge trap) and fill it to overflowing with water.
- c) Install VISY-Command Web or alternatively VISY-Command with a SECON client.
- d) Install VISY-Stick Oil (mechanically).

For installation of the measuring sensor, the oil reservoir of the oil separator must be within the measuring range of the VISY-Stick Oil.

Note: The dimensions $a_3 = 240$ mm and $a_4 = 100$ mm must not be undercut!

See also



User guide for determining the length and positioning of the probes for an oil separator. (See next figure)

- e) Install VISY-Sludge (mechanically).

The measuring sensor must be installed that it

- is positioned below the maximum oil layer thickness and
- at least 200 mm above the maximum sludge thickness, and
- has a maximum distance of 1400 mm to the bottom of the sludge trap.

- f) Electrically connect VISY-Stick Oil and VISY-Sludge with the FAFNIR connection cable and, if necessary, an extension to VISY-Command (Web).

 The oil separator is Ex zone. Observe safety regulations!

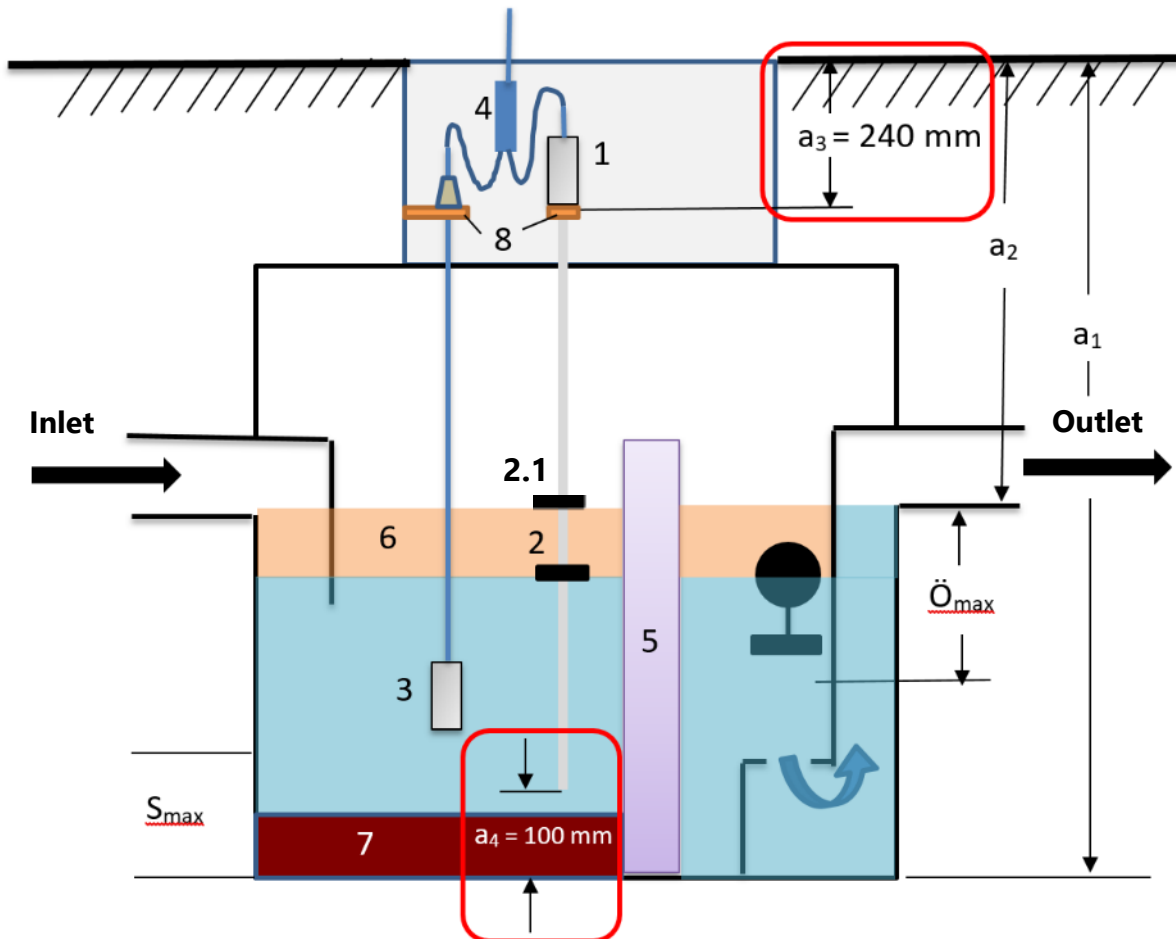

1 = VISY-Stick Oil

2 = Interface float

2.1 = Product float

3 = VISY-Sludge

4 = Cable connector (2-1)

5 = Coalescence filter

6 = Oil layer

7 = Mud layer

8 = Mounting bracket

O_{max} = Maximum oil layer thickness

S_{max} = Maximum sludge layer thickness

a_1 = Separator depth

a_2 = Distance (road - overflow)

a_3 = Safety distance = 240 mm

a_4 = Safety distance to the ground = 100 mm

2 Basic settings in VISY-Setup

To configure the VI-4 board in VISY-Command (Web), you must use **VISY-Setup** software in the **version 4.9.3.255** or higher. The recent version you will find on our homepage <https://www.fafnir.com>

The **VI-4 board** must be equipped with firmware of the **version 4.2.9.255** or higher.

To update the firmware please contact our Technical Support department with the telephone number +49 40 398207-0.



- a) Adjust the "**Data protocol** for communication with VISY-Stick" to "Multi Probe 4800 bps":
Menu:
Central unit [F2] → Advanced settings → Data Protocol for VISY-Stick communication → Select and accept "Multi Probe 4800 bps"

 - b) Enter the **device numbers** of VISY-Stick Oil / VISY-Sludge:
Menu:
Select Probes [F4] → select the "Probe Terminal No." of the sensor → select the measuring sensor (VISY-Stick or VISY-Sludge) → enter the "**Serial number of the probe**".

 - c) Select **Type of product** for the oil separator:
Menu:
Probes [F4] → Type of Product:
- Select "**light fluid**"

 - d) Enter the **Product Name**:
Menu:
Probes [F4] → Product name: Enter **Oil separator TF** ¹⁾
- 1) **Oil separator TF** (=tank field) or
Oil separator WS (=washing street)

3 Configuration

-  For configuration we recommend the internet browser "Mozilla Firefox".
-  The router must be set to Dynamic Host Configuration Protocol (DHCP)!
-  The SECON software must be in version 2.4.21.03 or higher.

3.1 Network connection between SECON-Client and notebook

- a) Connect your notebook via network cable to the router which is connected with SECON-Client / VISY-Command Web.
- b) To access the configuration menu of the SECON-Client, please enter:
User: admin
Password: vap22765
- c) Change the **language**:
 Configuration → Settings → Language and select your language (e. g. English)



3.2 Further configuration with the notebook

- Open the WEB GUI:
Configuration → Info → WEB GUI



Following window opens:

VAPORIX	LEVEL	Umwelt-Sensorik	Historie	Konfiguration
Konfiguration > Info > WEB GUI				
User GUI				
Adresse	https://10.28.199.213			
Benutzer	fafnir			
Passwort	fafnir22766			
Manuels	MENU: Info > Manuels			
Documents	MENU: Info > Documents			
Admin GUI				
Adresse	https://10.28.199.213/admin			
Benutzer	admin			
Passwort	*****			

- For configuration with the Internet browser (FireFox), copy the Admin GUI address from the Admin GUI field and enter it in the browser's address bar, in this example: <https://10.28.199.213/admin>

- After confirming the Admin GUI address in the internet browser, a new window opens for logging in with username and password:

User: **admin**

Password: **Fafnir22765Altona**

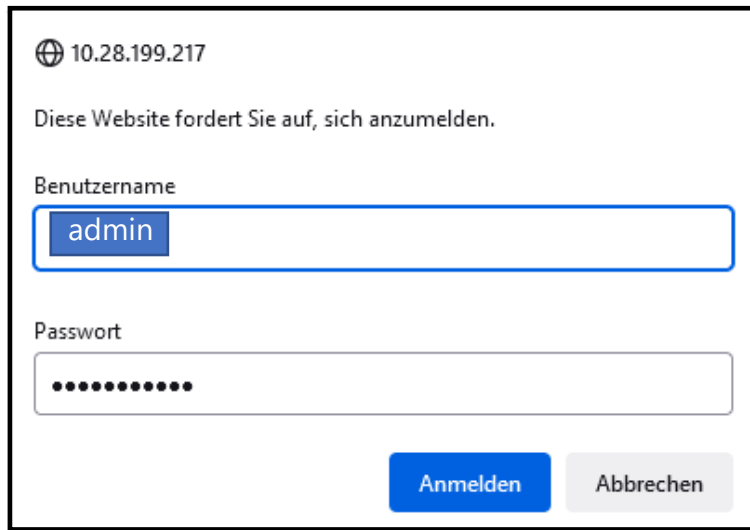

10.28.199.217

Diese Website fordert Sie auf, sich anzumelden.

Benutzername

admin

Passwort

.....

Anmelden Abbrechen

- With the button „Anmelden“ you will be logged in.
- The configuration wizard starts. Press the "Next" button

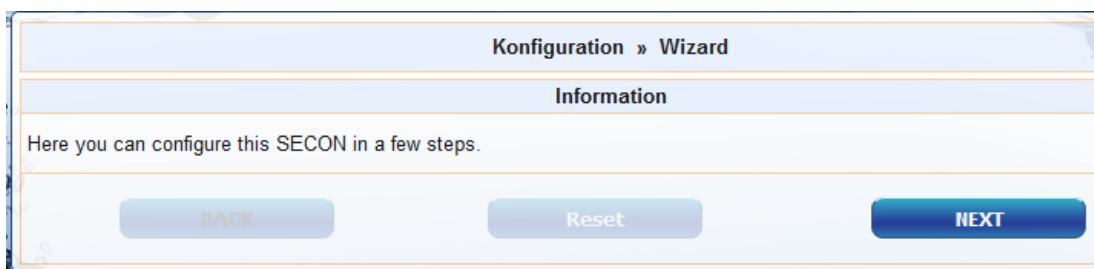

Konfiguration » Wizard

Information

Here you can configure this SECON in a few steps.

BACK Reset NEXT

- Select options "**Station data**" and "**Oil Separator**"

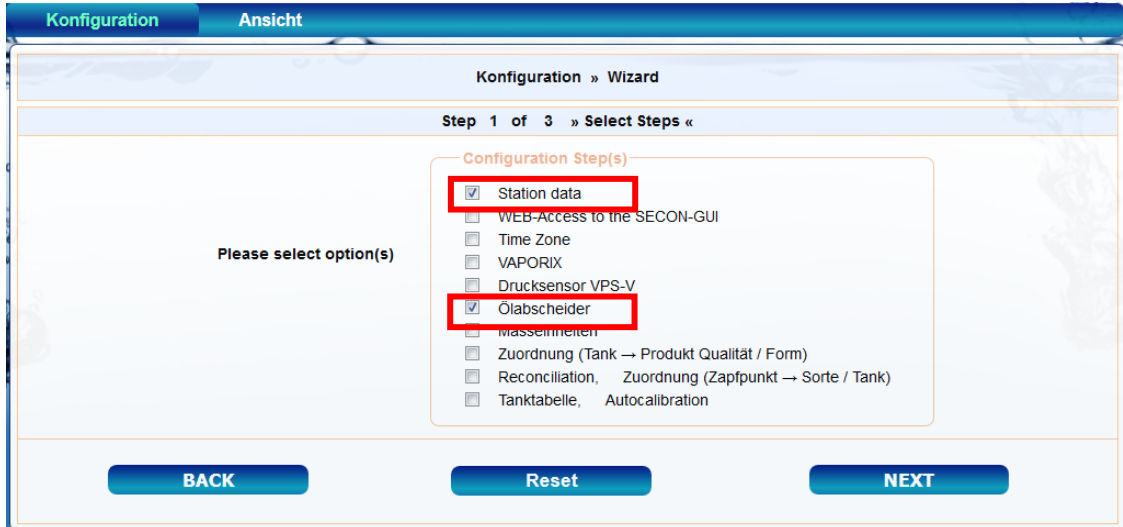

Konfiguration Ansicht

Konfiguration » Wizard

Step 1 of 3 » Select Steps «

Please select option(s)

Configuration Step(s)

- Station data
- WEB-Access to the SECON-GUI
- Time Zone
- VAPORIX
- Drucksensor VPS-V
- Ölabscheider
- Wasserleitungen
- Zuordnung (Tank → Produkt Qualität / Form)
- Reconciliation, Zuordnung (Zapfpunkt → Sorte / Tank)
- Tanktabelle, Autocalibration

BACK Reset NEXT

Press the "NEXT" button

- Enter the station data:

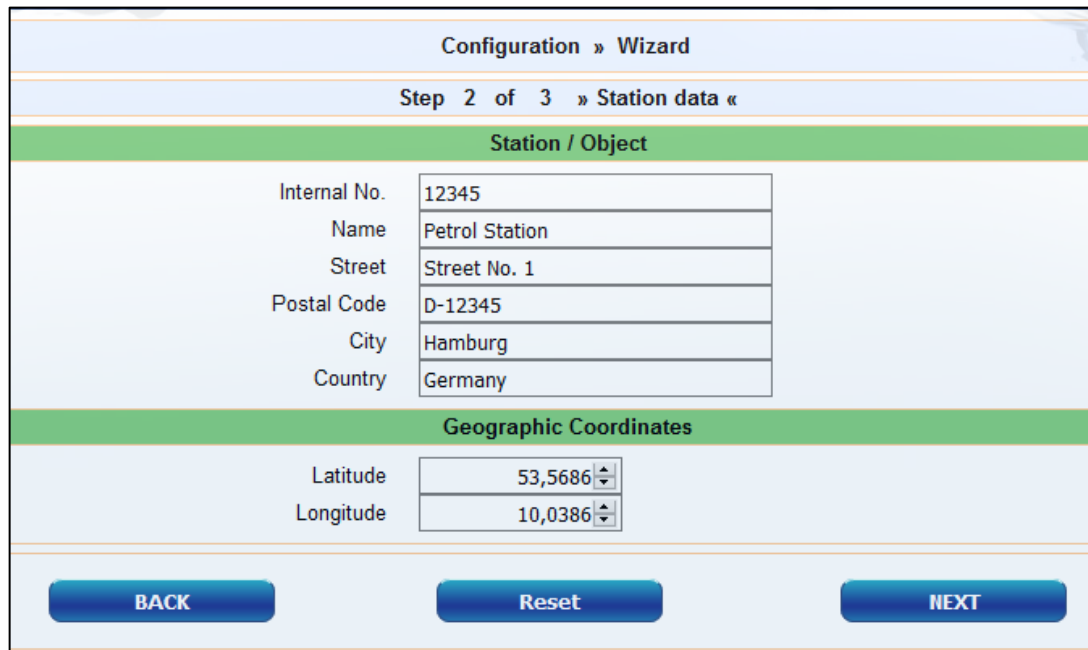

Configuration » Wizard

Step 2 of 3 » Station data «

Station / Object

Internal No.	12345
Name	Petrol Station
Street	Street No. 1
Postal Code	D-12345
City	Hamburg
Country	Germany

Geographic Coordinates

Latitude	53,5686
Longitude	10,0386

BACK Reset NEXT

- Determination of geographic coordinates (latitude and longitude, optional):
 1. Open the internet browser
 2. Start Google Maps
 3. Right click on the location of the station with the mouse
 4. In the opened context menu select "What is here?"
 5. The coordinates are displayed (latitude / longitude)
 6. Enter the geographical coordinates in the according fields
 7. Press the "NEXT" button

- Configuration of the oil separators and the evaluation

The following window is divided into three sections:

1. INFORMATION: Detected probes (sludge probe / tank probe)
2. Common settings for all oil separators
3. Settings for individual oil separators

1. INFORMATION: Detected probes

The measured values of the [Sludge Probe »VISY-Sludge«](#) and the [Tank Probe »VISY-Stick«](#) are displayed here.



Step 3 of 3 » Ölabscheider «			
INFORMATION: Detektierte Sonden [2019-05-20 13:33:15]			
Schlammsonde » VISY-Sludge «		Tanksonde » VISY-Stick «	
Sonde Nr.	Messwerte	Lev.[mm]	
6		900.0	
Produkt-Name / Sonde Nr.		Messwerte	Lev.[mm]
		Produkt	Water
Öl	6	1996.2	1966.0

2. Common settings for all oil separators

"**Logging**" area:

The settings in this area should remain unchanged.

The checkbox "Activation" is already activated by default.

"**Options**" area:

- **Time-out maintenance after:** 8 hours (recommendation)
- **Day of monthly inspection:** 0 (recommendation)
- **Alarm repeat »Light fluid too long constant« after:** 1 or 2 day (s) (recommendation)

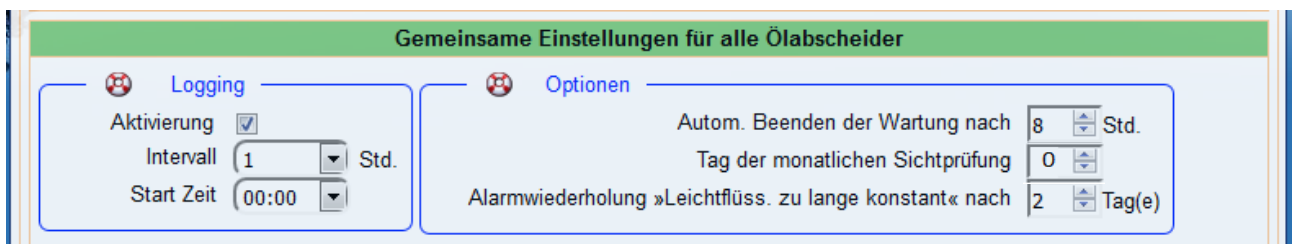

Gemeinsame Einstellungen für alle Ölabscheider	
Logging	
Aktivierung	<input checked="" type="checkbox"/>
Intervall	1 Std.
Start Zeit	00:00
Optionen	
Autom. Beenden der Wartung nach	8 Std.
Tag der monatlichen Sichtprüfung	0
Alarmwiederholung »Leichtflüss. zu lange konstant« nach	2 Tag(e)

3. Settings for individual oil separators

"Oil separator" area:

- **Number**: freely selectable; e.g. **1** for the first oil separator ...
- **Name**: choose a significant name, e.g.: City (HH); Station Number: 54; Number of the oil separator: 12345678

The name would then be, for example: **HH-54-12345678**

Idx.	Settings for individual Oil Separators
	<div style="border: 1px solid #0070c0; padding: 5px;"> <div style="display: flex; align-items: center;"> Oil Separator </div> <div style="display: flex; justify-content: space-between; margin-top: 5px;"> <div style="text-align: left;"> <p>Number <input style="width: 40px;" type="text" value="1"/></p> </div> <div style="text-align: left;"> <p>Identifier <input style="width: 150px;" type="text" value="HH-54-12345678"/></p> </div> </div> </div>

"Sludge probe »VISY-Sludge«" area:

- **Probe assigned to this oil separator**: Activate **the checkbox by a check mark**
- **Probe No.**: Probe terminal to which VISY-Sludge is connected.
- **Distance to oil separator bottom**: measured value VISY-Sludge
- **Alarm threshold of the mud layer**: **50% of the maximum permitted mud layer**

Sludge Probe » VISY-Sludge «

Assign probe to this Oil Sep.

Probe No.

Distance to Oil sep. bottom mm

Alarm threshold sludge layer mm

“Tank probe »VISY-Stick«” area:

- **Assign probe to this oil separator:** Activate **the checkbox by a check mark**
- **Probe No.:** Probe terminal to which VISY-Stick Oil is connected.
- **Reference filling height:** Corresponds to the reference height: measured value VISY-Stick
- **Max. light liquid volume:** enter here the maximum oil storage volume of the oil separator in **litres** - see also nameplate
- **Max. light liquid level:** enter here the maximum oil layer thickness that can be absorbed by the oil separator - see also nameplate
- **»Light liquid layer too thick« Alarm threshold:** Enter 80% of the maximum permitted oil layer thickness (see nameplate). It is necessary to check if the average volume can be taken up by the remaining 20%. Otherwise, the alarm threshold must be set to e.g 70%.

The average volume is calculated from the pump capacity of the dispenser with the highest flow rate per min. x 3.

Example 1: The highest pump capacity of the dispenser are 40 litres/minute => (40 L/min) x 3 min. = 120 litres

Example 2: The highest pump capacity of the dispenser are 80 litres/minute => (80 L/min) x 3 min. = 240 litres

- **»High level, retention« Alarm threshold:** enter here a value between **120** and **200** mm (measured from the reference height)

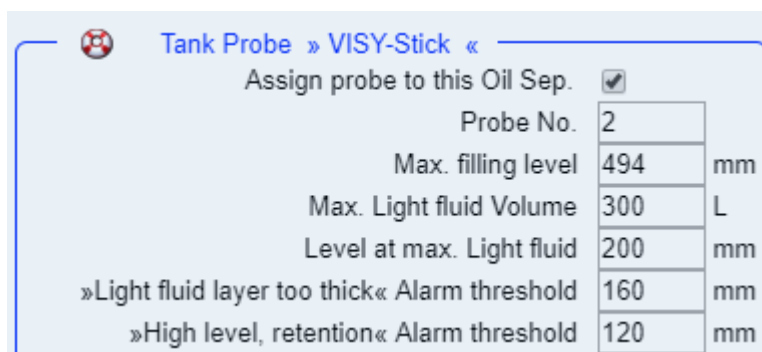

Tank Probe »VISY-Stick«		
Assign probe to this Oil Sep.	<input checked="" type="checkbox"/>	
Probe No.	2	
Max. filling level	494	mm
Max. Light fluid Volume	300	L
Level at max. Light fluid	200	mm
»Light fluid layer too thick« Alarm threshold	160	mm
»High level, retention« Alarm threshold	120	mm

“Alarm »light liquid too long constant«” area:

- Recognition time span: 25 days (recommendation)
- Minimum level change: 5 mm(recommendation)

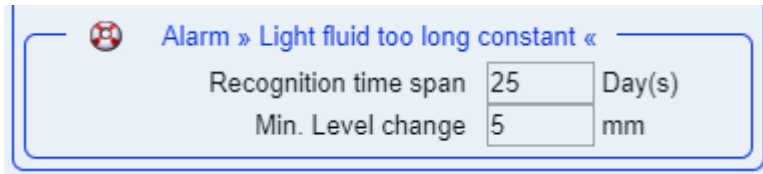

If another oil separator is to be added, then press the "**Add new Oil Separator**" button:

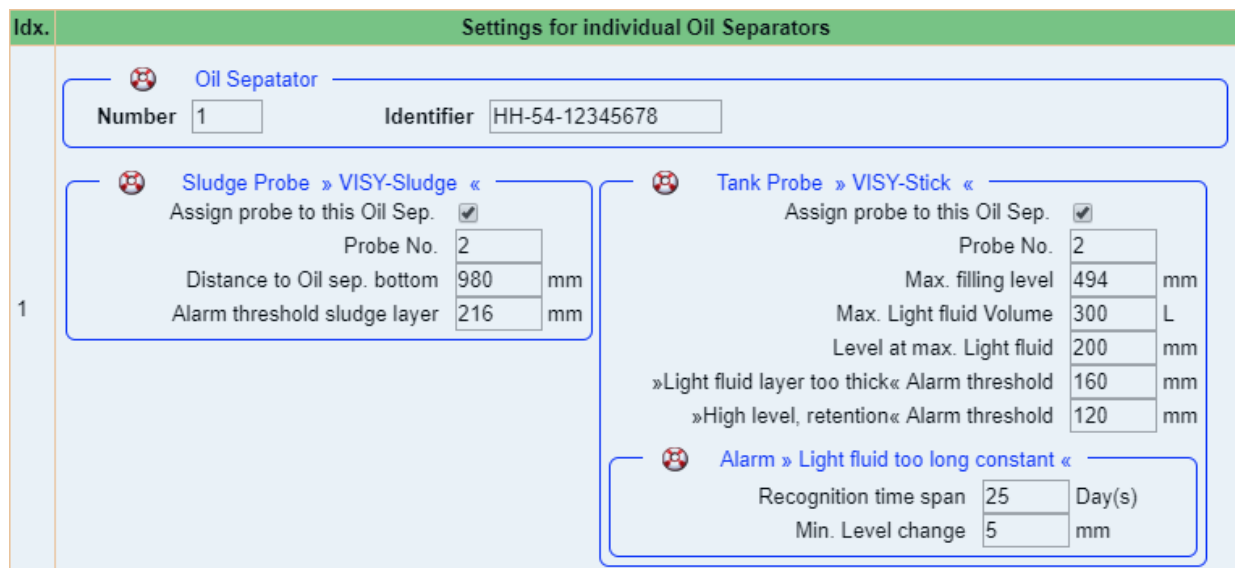
If no further oil separator is to be added, then press the "**NEXT**" button:



END of configuration

Blank Page



FAFNIR GmbH
Schnackenburgallee 149 c
22525 Hamburg, Germany
T: +49 / 40 / 39 82 07-0
F: +49 / 40 / 390 63 39
E-mail: info@fafnir.com
Web: www.fafnir.com
